

IGB Installation Instructions

Overview



MOBERN
LIGHTING

WARNINGS

- This product must be installed in accordance with all applicable codes by a person familiar with the product.
- Each fixture must be **properly supported** during install.
- **DO NOT** join fixtures on the floor prior to lifting, or damage will occur.
- **Before beginning installation**, review our complete list of warnings by visiting www.saylite.com/warnings.

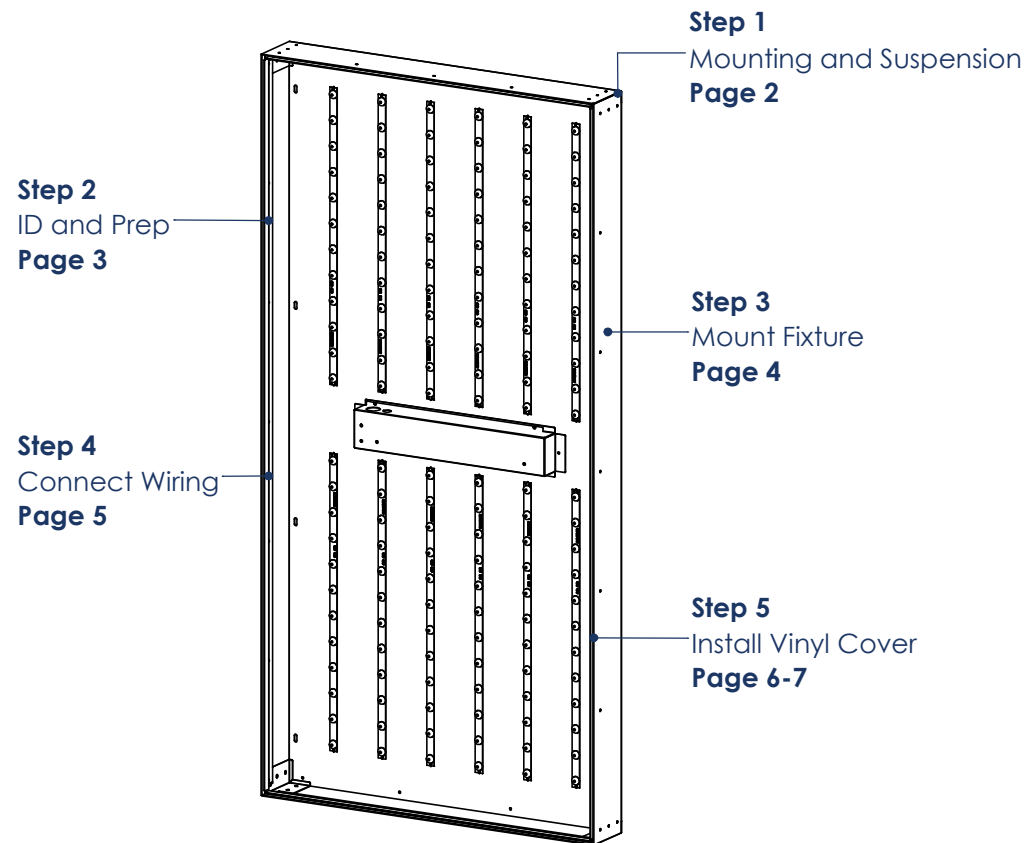

Your particular build may vary.

2020© Mobern Lighting Company | 8200 Stayton Dr., Suite 500, Jessup, MD 20794 | www.mobern.com

IGB Installation Instructions

Step 1 - Mounting and Suspension



MOBERN
LIGHTING

Mounting Options

Drywall or other hard surfaces* - Anchoring Screws

- Install anchor mounts at suspension locations.
- Ensure anchors are secure.
- Prepare fixture for mounting.

*Other hard surfaces include: wood, sheet metal panels, steel beams, concrete or masonry. Use hardware appropriate for each surface and material type.

Suspension Locations

X = Suspension Dimensions

Refer to Assembly Drawings and building plans to determine exact mounting, suspension points, and power feed locations.

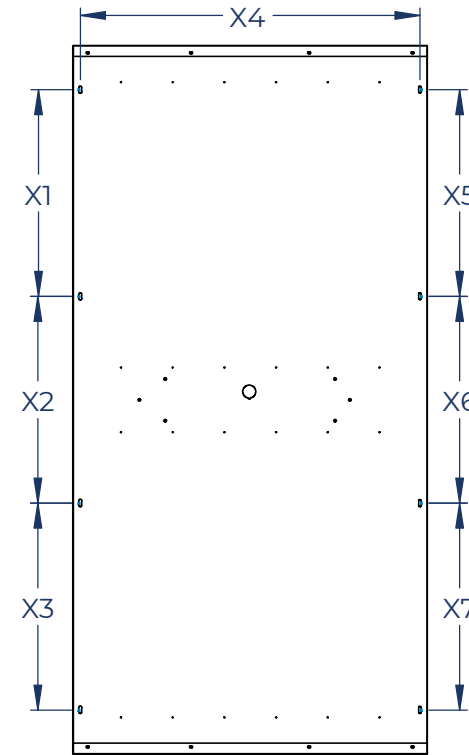

IGB Installation Instructions

Step 2 - Identification and Preparation



A. Identify Fixtures

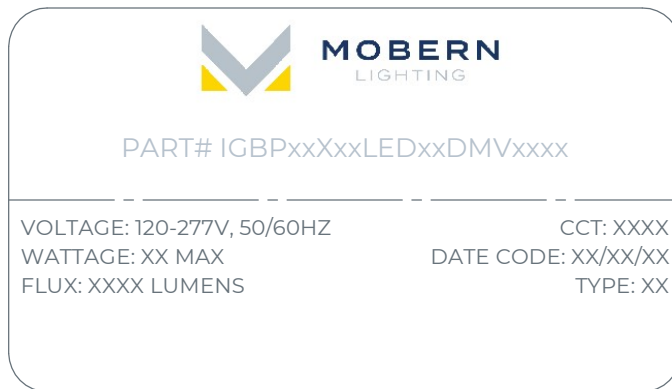

- Use labels found on the box and inside the fixture bodies to identify bodies.
- **NOTE:** Locations of labels can vary.
- Remove all fixtures from their boxes.
- Organize fixtures based on their labels at the install location.

Kitted Hardware

- Saylite has provided the items listed here, with their Saylite part numbers listed. These items can be found in separate boxes shipped with the fixture.
- Ensure all parts are accounted for and set them aside until needed.
- Any additional hardware needed for this installation will be provided by others.

B. Tools Needed

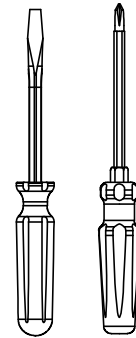

Screwdrivers



Pliers

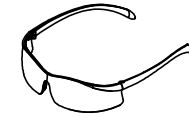

Safety Glasses

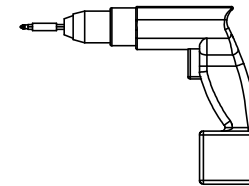

Drill
(optional)

- Always use proper safety equipment when installing fixtures.
- Tools shown are recommended for standard install. Tools needed may vary based on actual install location conditions.

IGB Installation Instructions

Step 3 - Mount the Fixture



MOBERN
LIGHTING

A. Prepare Fixture for Mounting

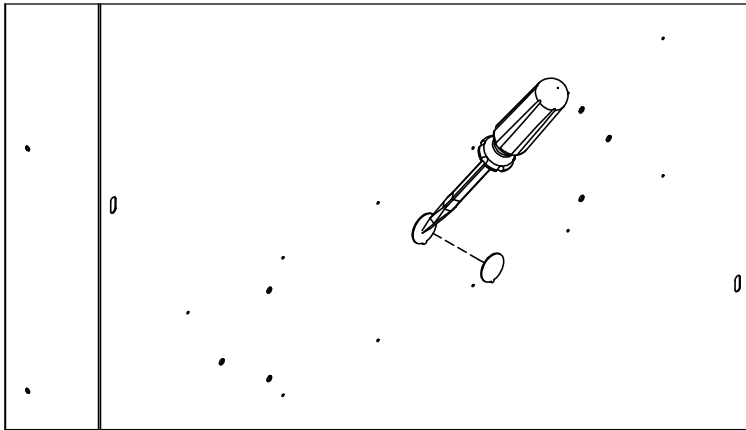

- Knock out 7/8" knockout on back of fixture using a flathead screwdriver.
- Use a gentle prying motion to remove knockout, and pull wiring through hole in fixture.
- Ensure an opening is available to feed the fixture wiring through the mounting surface.

B. Secure Fixture to Mounting Surface

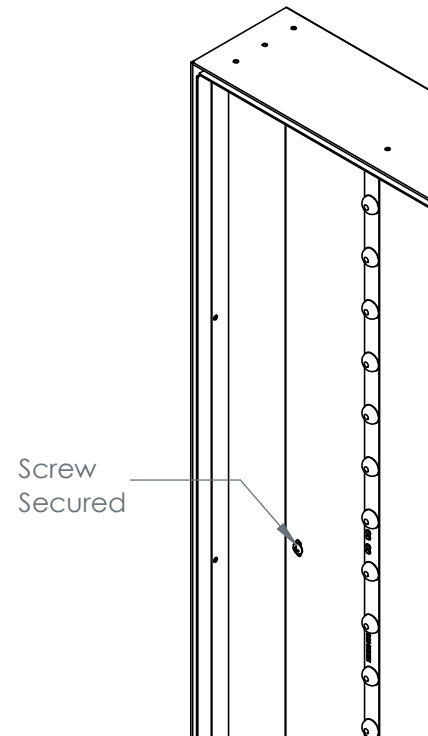

- Install mounting screws into screw anchors to secure fixture to mounting surface.

IGB Installation Instructions

Step 4 - Wire the Fixture



A. Connect Fixture Wiring

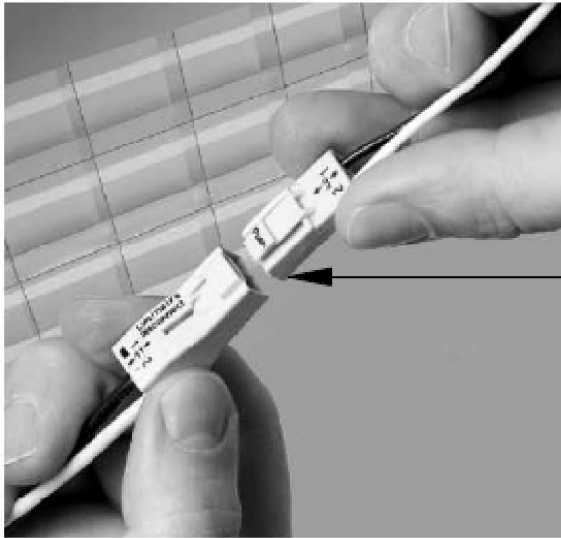

WIRING LEGEND		
BLACK	HOT	Line Voltage
WHITE	NEUTRAL	Line Voltage
GREEN	GROUND	
GRAY	DIMMING	0-10V DC
VIOLET	DIMMING	0-10V DC

- Once mounted, wire the fixture to the incoming power supply using the provided quick disconnect clip as shown.
- For dimming option, refer to wiring legend above.
- Use UL approved connectors only. Follow all local, state and national codes.

IGB Installation Instructions

Step 5 - Install Fabric Cover



MOBERN
LIGHTING

A. Install First Corner of Fabric

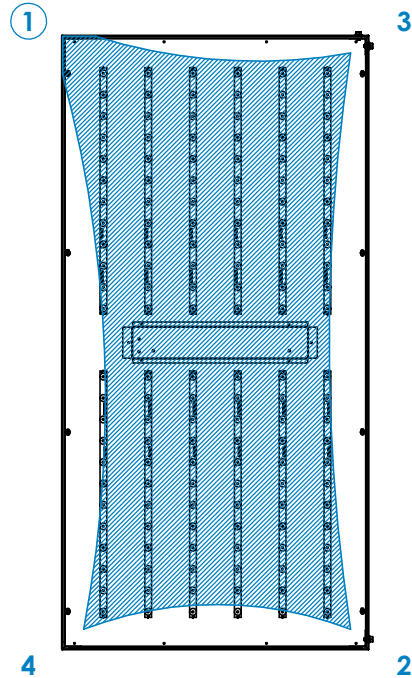

- Insert the fabric cover into corner 1 shown in the above diagram by tucking the cover edge into the small gap along the edge of the fixture.
- Insert approximately 3-6" of the cover in both directions going away from the corner.

B. Install Remaining Fabric Corners

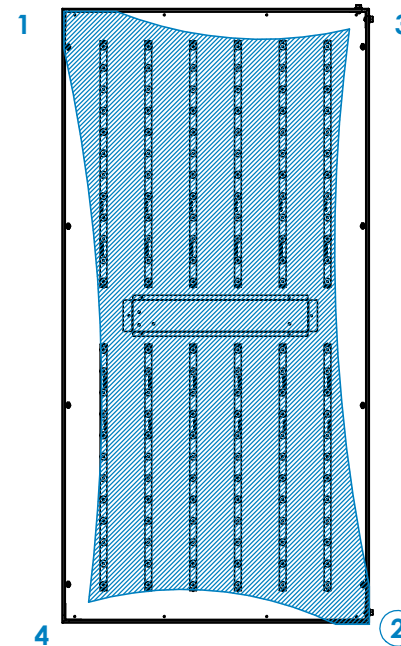

- Insert the fabric cover into corner 2 as shown in the above diagram by tucking the cover edge into the small gap along the edge of the fixture.
- Insert approximately 3-6" of the cover in both directions going away from the corner.
- Repeat these steps for corners 3 and 4 before continuing to the next page

IGB Installation Instructions

Step 5 - Install Fabric Cover (Cont'd)



MOBERN
LIGHTING

A. Install Sections A Thru D of Fabric Cover

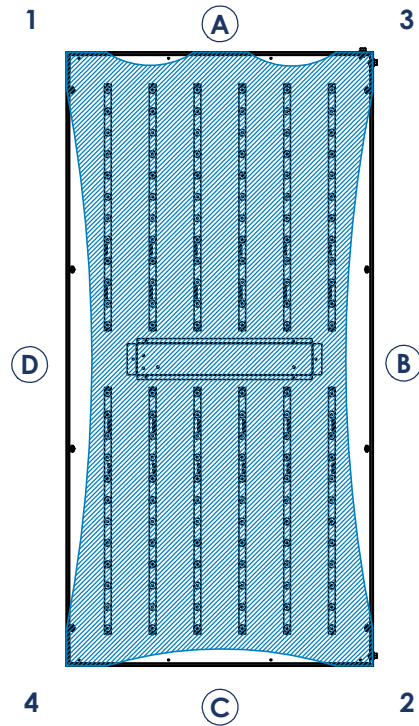

- Insert section A of the vinyl cover into the shadowbox frame by tucking the cover edge into the small gap along the edge of the fixture.
- Repeat in a clockwise fashion, continuing to sections B through D.

B. Install Remaining Sections of Fabric Cover

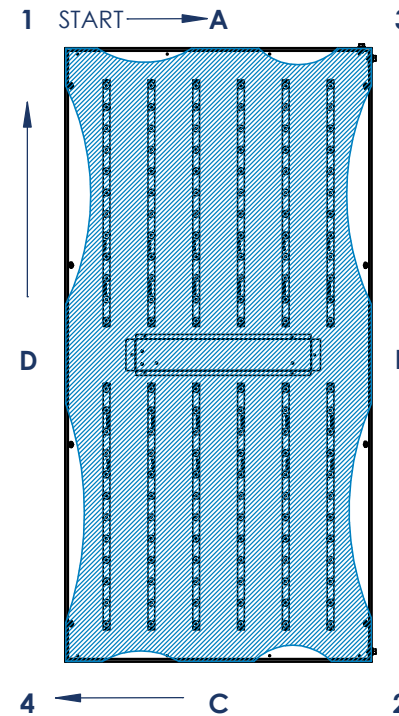

- Starting at the remaining untucked section between corner 1 and section A, insert the vinyl cover into the shadowbox frame.
- Repeat in a clockwise fashion, following the arrows in the above diagram until the vinyl cover is fully installed.
- Fixture installation is now complete.